

Carroparts

Carrosserie profielen

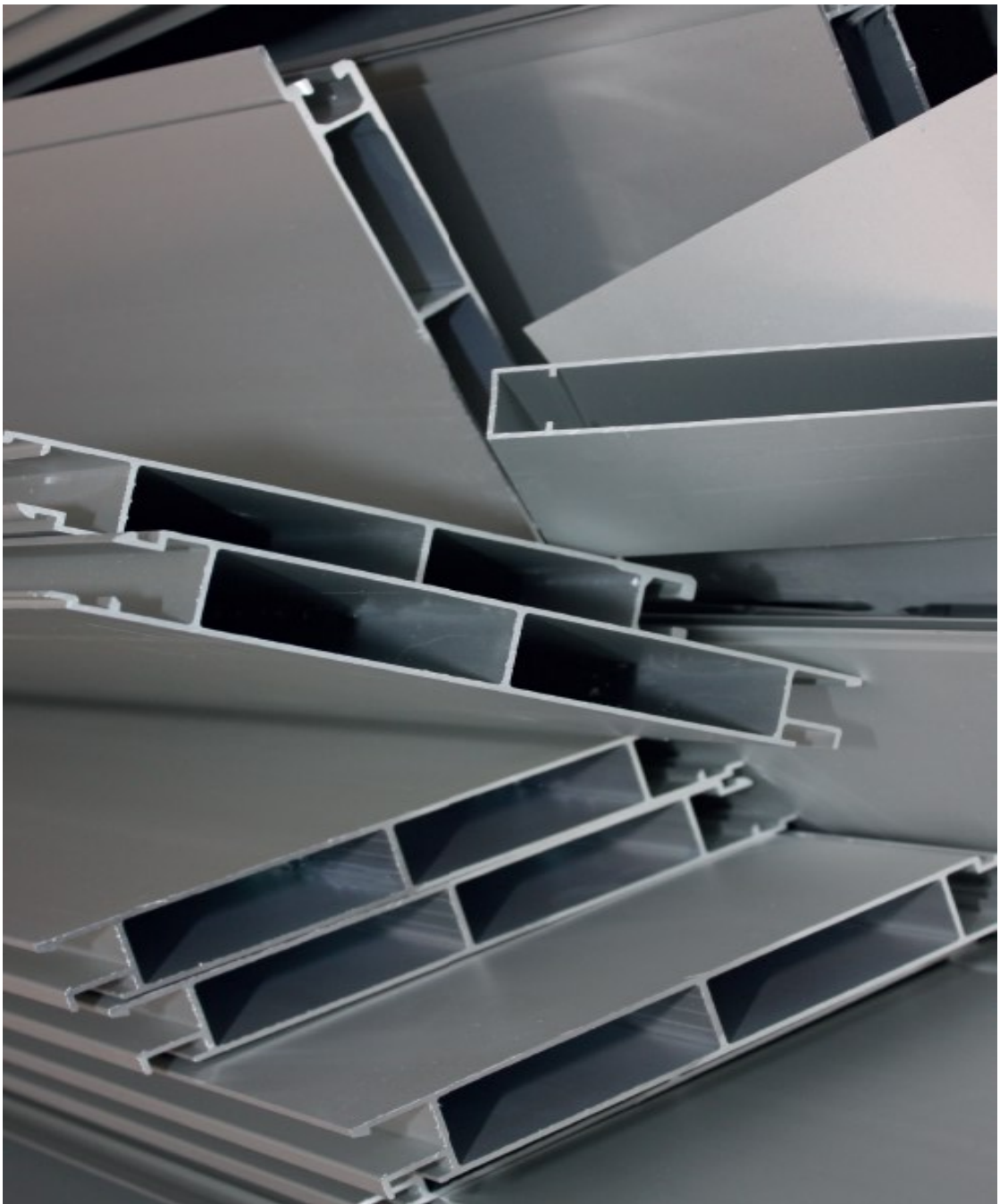

ALUMINIUM ZIJBORDPROFIELEN 25MM

BOVENRANDPROFIELEN

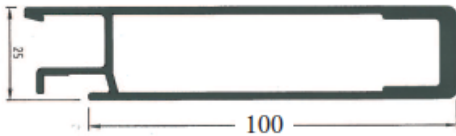

Artikelnummer
8-203-0001

| MATERIAAL | KG/M | LENGTE |
|-----------|--------|---------|
| ano | 1,7 kg | 7600 mm |

BOVENRANDPROFIELEN

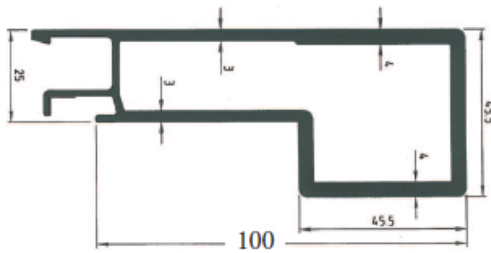

versterkte profielen

8-202-0001
8-400-0302

| MATERIAAL | KG/M | LENGTE |
|-----------|----------|---------|
| brut | 2,756 kg | 7600 mm |
| ano | 2,756 kg | 7600 mm |

BOVENRANDPROFIELEN

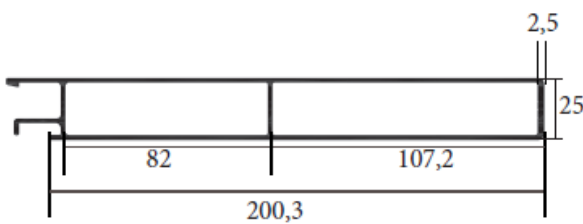

8-202-0008
8-203-0008
8-202-0009
8-203-0009

| MATERIAAL | KG/M | LENGTE |
|-----------|----------|---------|
| brut | 2,520 kg | 6500 mm |
| ano | 2,520 kg | 6500 mm |
| brut | 2,520 kg | 5200 mm |
| ano | 2,520 kg | 5200 mm |

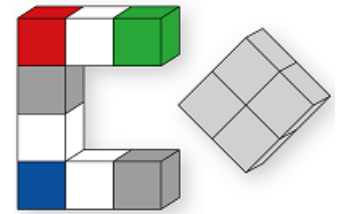

Carroparts

ONDERPROFIELEN

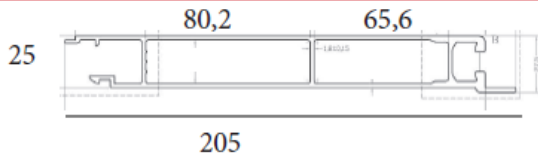

met lip

| Artikelnummer | MATERIAAL | KG/M | LENGTE |
|---------------|-----------|----------|---------|
| 8-202-0011 | brut | 2,685 kg | 6500 mm |
| 8-203-0011 | ano | 2,685 kg | 6500 mm |
| 8-202-0012 | brut | 2,685 kg | 5200 mm |
| 8-203-0012 | ano | 2,685 kg | 5200 mm |

ONDERPROFIELEN

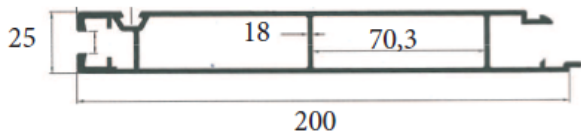

zonder lip

| Artikelnummer | MATERIAAL | KG/M | LENGTE |
|---------------|-----------|----------|---------|
| 8-202-0013 | brut | 2,585 kg | 7600 mm |
| 8-203-0013 | ano | 2,585 kg | 7600 mm |

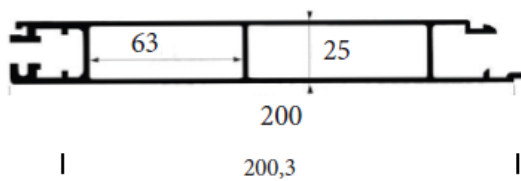

| | | | |
|------------|------|---------|---------|
| 8-202-0015 | brut | 2,68 kg | 7600 mm |
|------------|------|---------|---------|

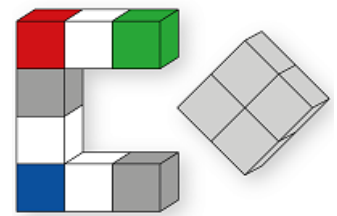

Carroparts

TUSSENPROFIELEN



| Artikelnummer | MATERIAAL | KG/M | LENGTE |
|---------------|-----------|--------|---------|
| 8-202-0006 | brut | 1,5 kg | 6500 mm |
| 8-203-0006 | ano | 1,5 kg | 6500 mm |

TUSSENPROFIELEN



| Artikelnummer | MATERIAAL | KG/M | LENGTE |
|---------------|-----------|--------|---------|
| 8-202-0018 | brut | 2,1 kg | 6500 mm |
| 8-203-018 | ano | 2,1 kg | 6500 mm |

TUSSENPROFIELEN



| Artikelnummer | MATERIAAL | KG/M | LENGTE |
|---------------|-----------|----------|---------|
| 8-202-0003 | brut | 2,550 kg | 6500 mm |
| 8-203-0003 | ano | 2,550 kg | 6500 mm |
| 8-202-0004 | brut | 2,550 kg | 5200 mm |
| 8-203-0004 | ano | 2,550 kg | 5200 mm |



DICHTING VOOR ZIJBORDPROFIEL

dichting EPDM



| Artikelnummer | ROL | KG/M |
|---------------|------|----------|
| 8-740-0026 | 25 m | 2,860 kg |

DICHTING VOOR ZIJBORDPROFIEL

dichting EPDM



| Artikelnummer | ROL | KG/M |
|---------------|------|------|
| 8-202-0500 | 35 m | 5 kg |



| Artikelnummer | KG/M |
|---------------|---------|
| 8-202-0501 | 0,05 kg |

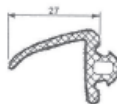

| | |
|------------|---------|
| 8-202-0502 | 0,11 kg |
|------------|---------|



| | |
|------------|---------|
| 8-740-0025 | 0,19 kg |
|------------|---------|

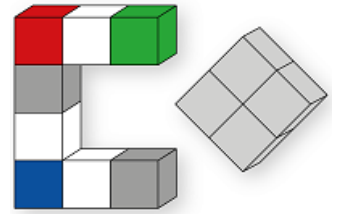

Carroparts

TIR PROFIELEN



| Artikelnummer | MATERIAAL | KG/M | LENGTE |
|---------------|-----------|--------|---------|
| 8-202-0005 | brut | 2,2 kg | 6500 mm |
| 8-203-0010 | ano | 2,2 kg | 6500 mm |

SLUITPROFIELEN K20

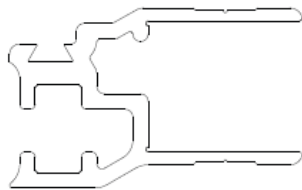

| | MATERIAAL | LENGTE |
|------------|-----------|---------|
| 8-202-0102 | brut | 7200 mm |
| 8-203-0113 | ano | 7200 mm |

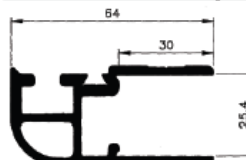

K20 achterbord

8-203-0114

| | | |
|--|-----|---------|
| | ano | 3000 mm |
|--|-----|---------|

SLUITPROFIELEN K4

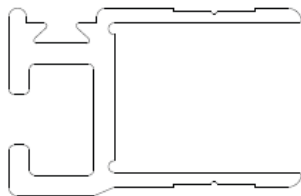

| | MATERIAAL | KG/M | LENGTE |
|------------|-----------|---------|---------|
| 8-202-0101 | brut | 1,35 kg | 7200 mm |
| 8-203-0101 | ano | 1,35 kg | 7200 mm |

SLUITPROFIELEN

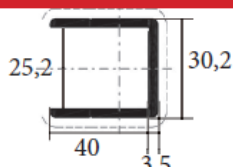

| | MATERIAAL | KG/M | LENGTE |
|------------|-----------|----------|---------|
| 8-202-0103 | brut | 0,765 kg | 4850 mm |
| 8-203-0103 | ano | 0,765 kg | 4850 mm |

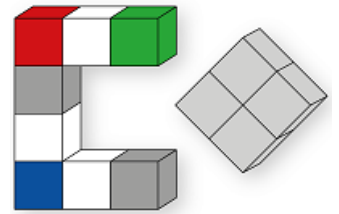

Carroparts

SLUITPROFIELEN

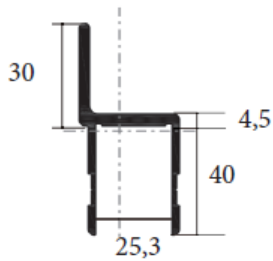

Artikelnummer
8-202-0105
8-203-0105

| MATERIAAL | KG/M | LENGTE |
|-----------|--------|---------|
| brut | 1,1 kg | 4800 mm |
| ano | 1,1 kg | 4800 mm |

SLUITPROFIELEN

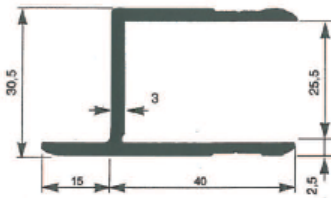

8-202-0100
8-203-0100

| MATERIAAL | KG/M | LENGTE |
|-----------|----------|---------|
| brut | 0,780 kg | 7200 mm |
| ano | 0,780 kg | 7200 mm |

SLUITPROFIELEN

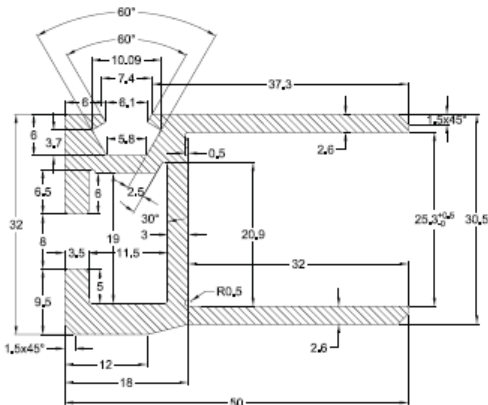

8-202-0104
8-203-0104

| MATERIAAL | KG/M | LENGTE |
|-----------|----------|---------|
| brut | 1,125 kg | 4850 mm |
| ano | 1,125 kg | 4850 mm |



ALUMINIUM PROFIELEN 300 MM

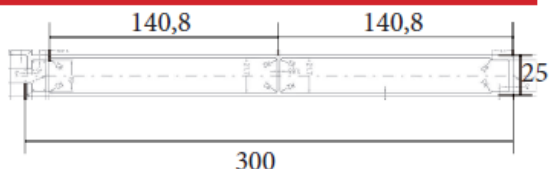

met lip

Artikelnummer

| | MATERIAAL | KG/M | LENGTE |
|------------|-----------|----------|---------|
| 8-200-0004 | brut | 3,396 kg | 6500 mm |
| 8-200-0002 | brut | 3,396 kg | 7600 mm |
| 8-201-0032 | ano | 3,396 kg | 6500 mm |
| 8-201-0010 | ano | 3,396 kg | 7000 mm |

ALUMINIUM PROFIELEN 300 MM

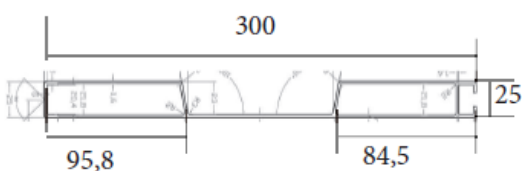

zonder lip | met TIR

| | MATERIAAL | KG/M | LENGTE |
|------------|-----------|----------|---------|
| 8-200-0030 | brut | 2,810 kg | 7600 mm |
| 8-201-0029 | ano | 2,810 kg | 6250 mm |
| 8-201-0030 | ano | 2,810 kg | 7000 mm |
| 8-201-0028 | ano | 2,810 kg | 7600 mm |

ALUMINIUM PROFIELEN 300 MM

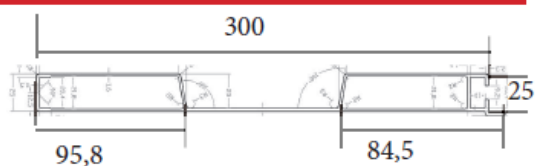

met lip | met TIR

| | MATERIAAL | LENGTE |
|------------|-----------|---------|
| 8-201-0027 | ano | 5000 mm |

BUISPROFIELEN 300 MM

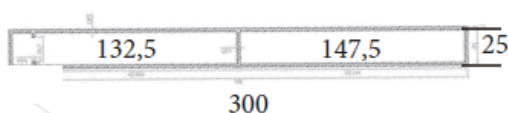

| | MATERIAAL | KG/M | LENGTE |
|------------|-----------|----------|---------|
| 8-200-0001 | brut | 2,990 kg | 7600 mm |
| 8-201-0007 | ano | 2,990 kg | 7000 mm |
| 8-201-0005 | ano | 2,990 kg | 5000 mm |

ALUMINIUM PROFIELEN 400 MM

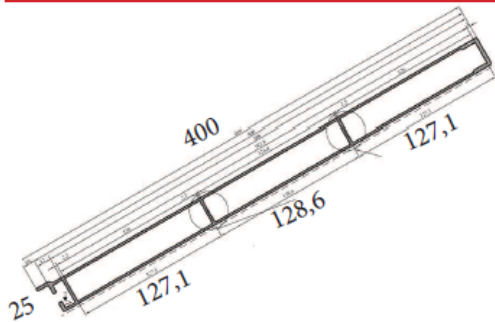

met lip

| Artikelnummer | MATERIAAL | KG/M | LENGTE |
|---------------|-----------|----------|---------|
| 8-200-0011 | brut | 4,760 kg | 6500 mm |
| 8-200-0010 | brut | 4,760 kg | 7500 mm |
| 8-201-0012 | ano | 4,760 kg | 6500 mm |
| 8-201-0011 | ano | 4,760 kg | 7500 mm |

ALUMINIUM PROFIELEN 400 MM

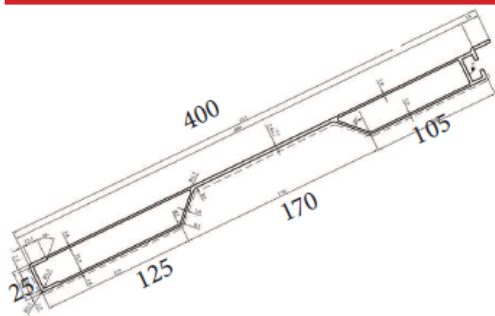

met lip | met TIR

| Artikelnummer | MATERIAAL | KG/M | LENGTE |
|---------------|-----------|----------|---------|
| 8-201-0013 | ano | 3,924 kg | 7000 mm |
| 8-201-0014 | ano | 3,924 kg | 7600 mm |

ALUMINIUM PROFIELEN 400 MM

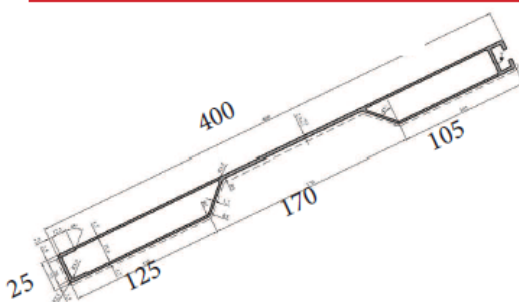

zonder lip | met TIR

| Artikelnummer | MATERIAAL | KG/M | LENGTE |
|---------------|-----------|----------|---------|
| 8-201-0015 | ano | 3,940 kg | 7500 mm |



stootlijst kunststof

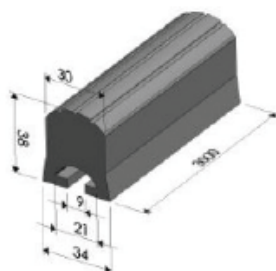

8-330-0020

| KG/M | LENGTE |
|------|---------|
| 1 kg | 3000 mm |

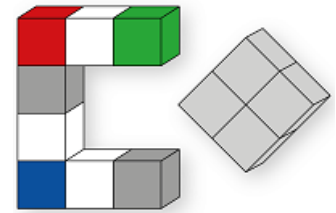

Carroparts

caravan rail

Artikelnummer

8-208-0001

8-208-0002

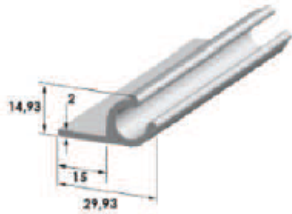

| | MATERIAAL | LENGTE | KG/M |
|------------|-----------|---------|----------|
| 8-208-0001 | brut | 6500 mm | 1,920 kg |
| 8-208-0002 | ano | 6500 mm | 1,920 kg |

profiel waterlijst

8-209-0001

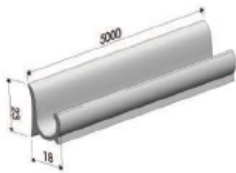

| | MATERIAAL | LENGTE | KG/M |
|------------|-----------|---------|--------|
| 8-209-0001 | brut | 5000 mm | 1,1 kg |

profiel half-rond | brut

8-105-0001

8-105-0004

8-105-0002

8-105-0003

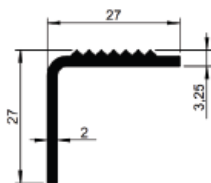

| | BREEDTE | LENGTE |
|------------|---------|---------|
| 8-105-0001 | 30 mm | 5000 mm |
| 8-105-0004 | 16 mm | 5000 mm |
| 8-105-0002 | 19 mm | 5000 mm |
| 8-105-0003 | 25 mm | 6000 mm |

hoekprofiel anti-slip 27x27

8-105-0020

| | LENGTE |
|------------|---------|
| 8-105-0020 | 5000 mm |

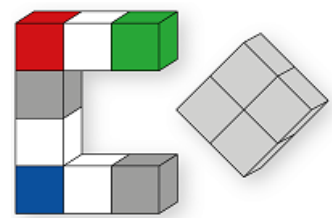

Carroparts

ALUMINIUM STOOTLIJST BRUT

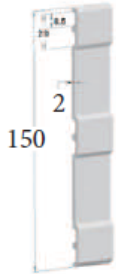

Artikelnummer
8-207-0002

| BREEDTE | LENGTE | DIKTE | KG/M |
|---------|---------|-------|----------|
| 150 mm | 5000 mm | 2 mm | 0,917 kg |

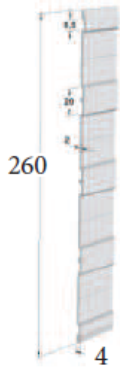

8-207-0001

| BREEDTE | LENGTE | DIKTE | KG/M |
|---------|---------|-------|----------|
| 260 mm | 5000 mm | 4 mm | 1,564 kg |

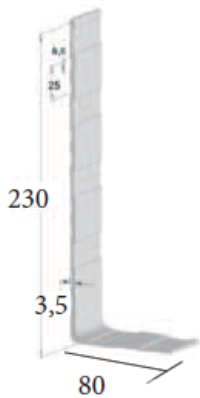

8-207-0004

| BREEDTE | LENGTE | DIKTE | KG/M |
|---------|---------|--------|----------|
| 230 mm | 7000 mm | 3,5 mm | 2,367 kg |



8-207-0003

| BREEDTE | LENGTE | DIKTE | KG/M |
|---------|---------|-------|----------|
| 70 mm | 7000 mm | 3 mm | 0,727 kg |

STAPELBARE PROFIELEN



Artikelnummer
8-204-0101
8-204-0100

| MATERIAAL | LENGTE | KG/M |
|-----------|---------|----------|
| brut | 7800 mm | 1,720 kg |
| brut | 6600 mm | 1,720 kg |

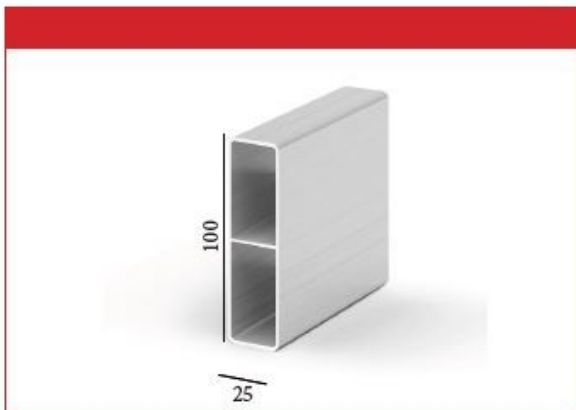

8-204-0102

| MATERIAAL | LENGTE | KG/M |
|-----------|---------|----------|
| brut | 6600 mm | 1,250 kg |

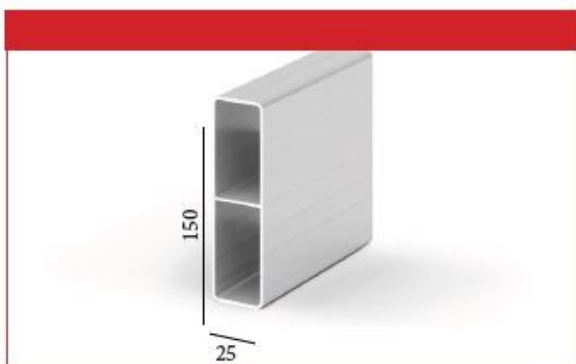

8-204-0103

| MATERIAAL | LENGTE | KG/M |
|-----------|---------|----------|
| brut | 6600 mm | 1,632 kg |